

INSTRUCTIONS FOR REPAIR OF ALL KETCH-ALL POLES

(Refer To Ketch-All Parts List For Parts Numbers)

TO REMOVE CABLE

1. Remove large lock ring #7 located behind collar #8.
2. Pull collar #8 back toward rear of pole until head #9 is exposed.
Note: it may be necessary to slide toothguard #5 back in order to pull collar back.
3. Remove head #9, which is right hand thread, leaving collar #8 on pole.
IF APPLICABLE: remove allen set screw #6 (with allen wrench) located on head.
4. When head #9 is free, pull release knob #1 back and hold in this position (we suggest using vice grips) while pulling cable out through the other end of pole.
5. Pull cable spring from hair guard #23.

TO INSTALL CABLE

1. Insert ball of cable through hair guard #23 (which should be attached to head shank #9), running cable through until hair guard #23 meets cable spring.
2. Screw hair guard #23 into cable spring. The cable is now ready to install.
3. Insert cable through tubing #3, pulling back on release knob #1 to allow cable to pass through locking device.
4. Screw head onto end of pole.
5. Insert cable ball in groove or track in head #9.
6. Pull collar #8 over head and cable ball, and replace lock ring #7.
IF APPLICABLE: replace set screw #6.

TO DISASSEMBLE LOCKING DEVICE

1. Pull back on release knob #1, turning it until hole in tubing lines up with hole in cage #20.
2. Insert ice pick or nail through holes, thus keeping locking device from turning.
3. Remove release knob #1, which is a right hand thread. There should be a lock washer #16 inside release knob.
4. Remove: lock ring #17, step washer #18, compression spring #19, cage #20 and three ball bearings #21.

TO REPLACE HEAD

To replace head, follow steps under headings: To Remove Cable and To Install Cable above. You will damage about one inch of cable spring when you pull the old head off. This should be cut off to enable you to screw the new hair guard into the part of the spring that remains intact.

INSTRUCTIONS FOR OPERATING STANDARD KETCH-ALL POLES

1. Pull excess cable from storage hole at upper end of Ketch-All. With one hand, hold grip #2 toward middle of pole, and with your free hand, pull back on release knob #1, allowing cable to **gradually** slip forward through the palm and fingers. This prevents the end of the cable from whipping, and allows the other end to automatically form a loop which is ready to use.
2. Place the loop over the animal's head or other part of body.
3. Pull the end of the cable behind the release knob. This tightens the loop around the animal, with the cable locking automatically as it is drawn in.
4. To release the loop, merely pull back on release knob as in operation number one. **(If too much tension is applied to loop, the cable may fail to release. For best results, do not pull back on pole while attempting to release cable.)**

INSTRUCTIONS FOR OPERATING TELESCOPIC EXTENSION POLES

Do not suspend or lift heavy animals unless pole is retracted.
When retracted, the extension pole is a heavy duty restraining device.

1. Pull back on release knob to expand loop.
2. Hold 1' tubing next to chuck, turning chuck to right to free 7/8" tubing.
3. Push 7/8" tubing forward until loop is closed.
4. Turn chuck to left, thus keeping extension in place. Repeat above steps until desired length is attained.
5. To retract telescopic pole, turn chuck to right until inner tubing moves freely, then pull cable until pole is retracted to tooth guard #5.
6. When in the process of extending the pole, watch for two red warning marks on inner tubing. For best results, do not extend past second mark. If poles should become separated, release locking device, and slide back together.
7. Follow additional Instructions as shown for operating Standard Poles.

INSTRUCTIONS FOR CARE:

When the Ketch-All is not in use for long periods of time, **do not leave loop tightly drawn.** Leave loop about half open thus taking tension off cable spring. Lubricate cable and other working parts occasionally with light machine oil through the hole at the top of release knob. Manufactured in the U.S.A., the Ketch-All is made of only high quality materials, and with proper care, it should provide long and useful service. See diagram and parts list for identification of replaceable parts. When ordering new parts, please specify length and type (standard or extension) of pole.

KETCH-ALL PARTS LIST

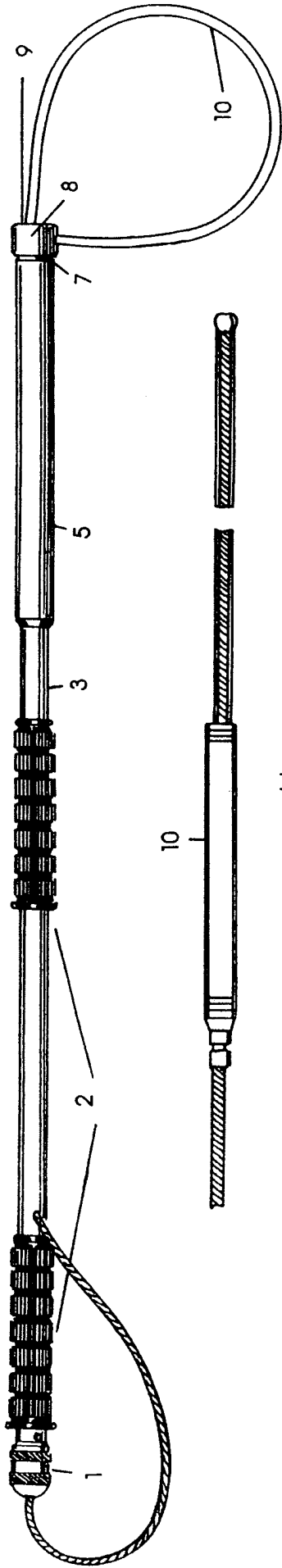

cable

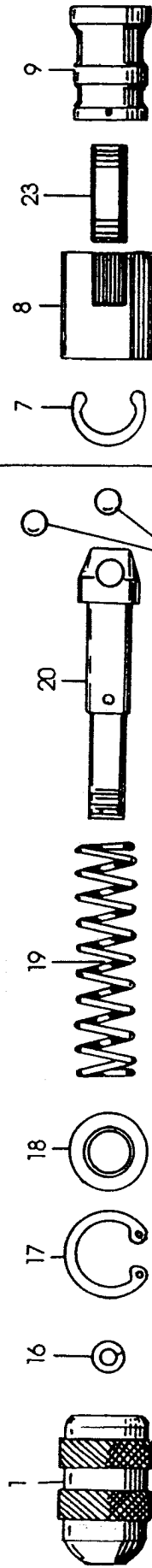

Locking Device Complete

Head Complete

(Older models may have set screw in head shank; newer models do not.)

(Chuck #4 and chuck ring #22 used only on extension poles)

- | | |
|---------------------------------|---------------------------------|
| 1. Release knob | 9. Head |
| 2. Grips | 10. Steel cable |
| 3. Tubing | 16. Release knob lock washer |
| 4. Chuck (extension poles only) | 17. Cage lock ring |
| 5. Toothguard | 18. Step washer |
| 6. Allen set screw | 19. Compression spring |
| 7. Head lock ring | 20. Cage |
| 8. Collar | 21. 9/32 ball bearings |
| | 22. Chuck ring (ext. pole only) |
| | 23. Hair guard |

IMPORTANT: When ordering parts please specify length of pole and whether it is a standard or extension pole.

How to Use a Control Pole

The next time a call comes in, whether it's for a stray dog or a raccoon, remember that the control pole ("catch pole," "come-along," or "rabies pole" as it's sometimes called) is designed to gently coax animals to safety. Its use as a weapon is inappropriate, and could easily endanger the animal and the animal control officer. Remember that control poles should not be used on cats. The use of a net is the most humane and effective way of capturing a cat, and it will be detailed in the next issue of *Animal Sheltering*.

Lastly, before you hop out of the truck, it's important to quickly examine the control pole, making sure that cable and release mechanisms are operating smoothly. Be sure the loop retains a rounded shape rather than a tear shape by storing the pole on a flat surface or using broom clips. Replace cables every 18-24 months as a part of regular maintenance.

Most animal control officers consider the control pole one of the most valuable tools of the trade. But like a carpenter's hammer or drill, a control pole is only as effective as the person holding it in his or her hands.

1: Easy Does It.

Approach the dog slowly, holding the control pole directly behind you or at your side, with the cable loop hanging loosely. *Never* approach a dog with a control pole held high, like a weapon, as this will set the tone for the entire encounter.

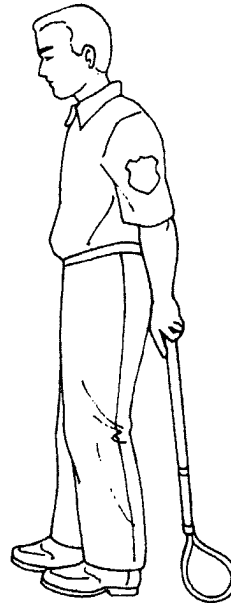
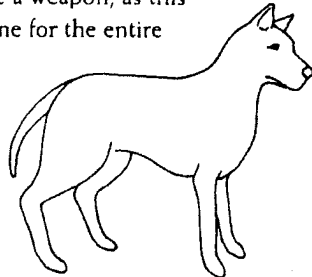

3: Lead By Following.

Keep both hands a slight distance apart on the pole. Once the loop is secured about the animal's neck, stand beside the dog and slowly guide the animal ahead. Most dogs will readily walk forward if you remain in their field of vision, but in some cases walking directly behind them may prompt them to move ahead.

2: It's All In The Wrist.

Using both hands, slip the noose smoothly over the dog's head until the loop is around the animal's neck. Use one hand to pull the release cord to tighten the cable until the loop fits snugly, but not too tight. The pole is designed to maneuver the animal, so it is important *never* to use the control pole to choke the animal or force him into submission.

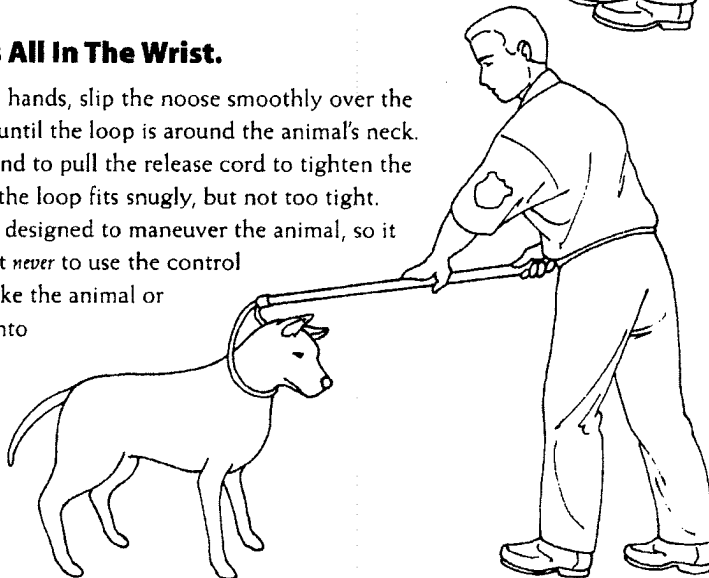

Illustrations by Susie Duckworth

Continued on reverse side





4: Don't Try To Pull One Over.

Never drag, yank, pull, or lift a dog with a control pole. Since dogs are often put in a truck for transport, it's a good idea to bring a ramp (a piece of plywood will do) to direct them into a cage. Then, just loosen the cord, and while carefully closing the cage door with one hand, remove the control pole with the other.

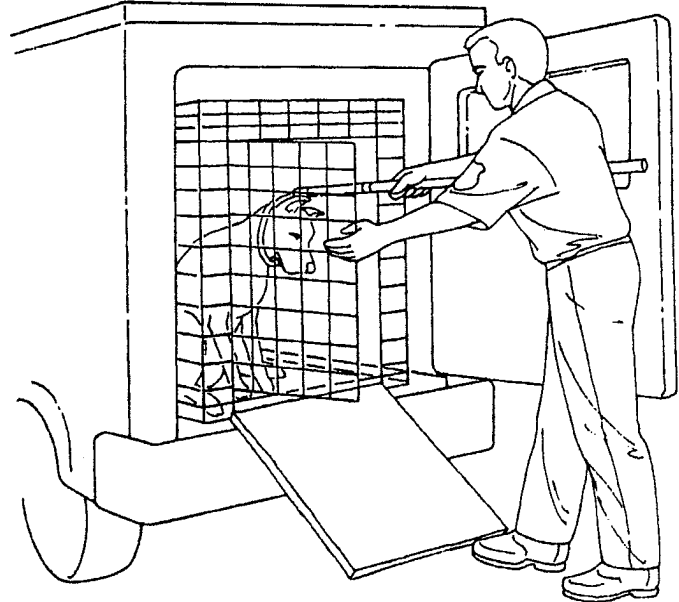
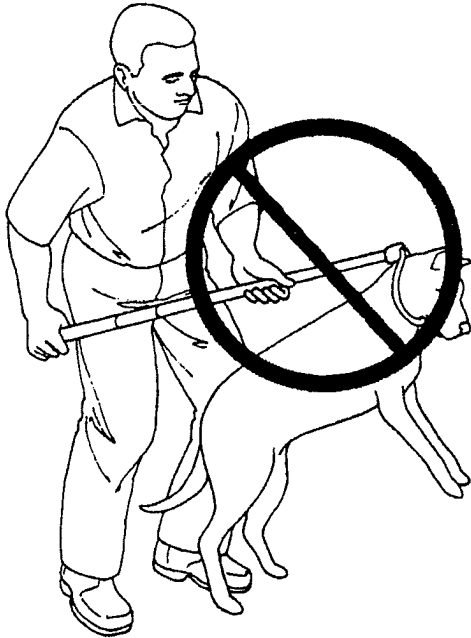

Wild Ones.

It may be necessary to temporarily restrain some wild animals (such as raccoons) using the control pole. These animals should *never* be looped solely around the neck or chest. Instead, the cable should be looped "bandolier-style" around the neck and under one of the front legs, and the animal should be guided in the manner described previously.

